

LED magnetic-strip retrofit kits

Installation instruction

IMPORTANT

READ CAREFULLY BEFORE INSTALLING THE RETROFIT KIT. RETAIN THESE INSTRUCTIONS FOR FUTURE REFERENCE.

THOROUGHLY INSPECT THE FIXTURE FOR ANY FREIGHT DAMAGE; FREIGHT DAMAGE SHOULD BE REPORTED TO THE DELIVERY CARRIER.

LED retrofit kits must be wired in accordance with the National Electrical Code and all applicable local codes. Proper grounding is required for safety.

This product **MUST** be installed in accordance with the applicable installation code by a person familiar with the construction and operation of the product.

The luminaries must be installed by qualified electrician.

GETTING STARTED

LED troffer retrofit kit is designed to replace fluorescent lamps within conventional recessed mount fluorescent troffers or surface mount strip fixtures in dry and damp locations.

Following items are included in the box:

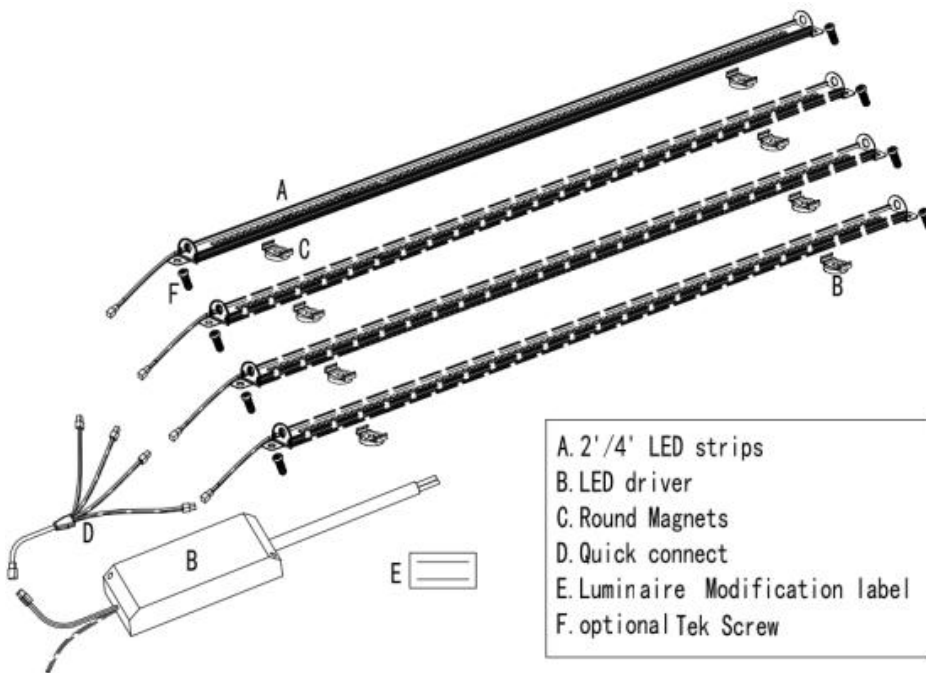

WARNING

RISK OF FIRE OR ELECTRIC SHOCK. Make sure power supply is OFF before installing or maintaining the product.

RISK OF FIRE OR ELECTRIC SHOCK. Install this product only in the luminaires that have the construction features and dimensions shown in the photographs and/or drawings and where the input rating of the product does NOT exceed the input rating of the luminaires.

RISK OF FIRE OR ELECTRIC SHOCK. To prevent wiring damage or abrasion, do not expose wiring to edges of sheet metal or other sharp objects.

RISK OF FIRE OR ELECTRIC SHOCK. LED retrofit kit installation requires knowledge of luminaires electrical systems. If not qualified, do not attempt installation. Contact a qualified electrician.

RISK OF FIRE OR ELECTRIC SHOCK. Only those open holes indicated in the photographs and/or drawings may be made or altered as a result of kit installation. Do not make or alter any open holes in an enclosure of wiring or electrical components during installation.

RISK OF FIRE OR ELECTRIC SHOCK. Never perform maintenance or cleaning while fixture is energized. Disconnect power and allow fixture to cool before maintaining.

RISK OF INJURY. Wear safety glasses and gloves during installation and servicing.

THIS DEVICE IS NOT INTENDED FOR USE WITH EMERGENCY EXITS.

RISK OF FIRE OR ELECTRIC SHOCK. LUMINAIRES WIRING, POWER SUPPLY, OR OTHER ELECTRICAL PARTS MAY BE DAMAGED WHEN DRILLING FOR INSTALLATION OF RETROFIT ASSEMBLY HARDWARE. INSPECT WIRING AND COMPONENTS FOR DAMAGE.

SHOCK AND FIRE HAZARD, DO NOT USE WHEN ENCLOSURE IS BROKEN.

TO AVOID POTENTIAL FIRE OR SHOCK HAZARD, DO NOT USE THIS RETROFIT KIT IN LUMINAIRES EMPLOYING SHUNTED BI-PIN LAMP HOLDERS. NOTE: SHUNTED LAMP HOLDERS ARE FOUND ONLY IN FLUORESCENT LUMINAIRES WITH INSTANT-START BALLASTS. INSTANT-START BALLASTS CAN BE IDENTIFIED BY THE WORDS "INSTANT START" OR "I.S." MARKED ON THE BALLAST. THIS DESIGNATION MAY BE IN THE FORM OF A STATEMENT PERTAINING TO THE BALLAST ITSELF, OR MAY BE COMBINED WITH THE MARKING FOR THE LAMPS WITH WHICH THE BALLAST IS INTENDED TO BE USED, FOR EXAMPLE F40T12/IS. FOR MORE INFORMATION, CONTACT THE LED LUMINAIRE RETROFIT KIT MANUFACTURER.

INSTALLERS SHOULD NOT DISCONNECT EXISTING WIRES FROM LAMP HOLDER TERMINALS TO MAKE NEW CONNECTIONS AT LAMP HOLDER TERMINALS. INSTEAD INSTALLERS SHOULD CUT EXISTING LAMP HOLDER LEADS AWAY FROM THE LAMP HOLDER AND MAKE NEW ELECTRICAL CONNECTIONS TO LAMP HOLDER LEAD WIRES BY EMPLOYING APPLICABLE CONNECTORS.



REPLACE ONLY WITH LED Driver. See below table.

Model No.	LED driver model
34594A	LFUC1-040W-02-21, BQE45C-1000-40-PV, BQE46-1000-42-PV-S1
34595A	LFUC1-040W-02-21, BQE45C-1000-40-PV, BQE46-1000-42-PV-S1
34596A	LFUC1-040W-02-21, BQE45C-1000-40-PV, BQE46-1000-42-PV-S1
34597A	LFUC1-040W-02-21, BQE45C-1000-40-PV, BQE46-1000-42-PV-S1
34598A	LFUC1-040W-02-21, BQE45C-1000-40-PV, BQE46-1000-42-PV-S1
34599A	LFUC1-030W-02-21, BQE45C-750-40-PV, BQE46-1000-42-PV-S1
34600A	LFUC1-030W-02-21, BQE45C-750-40-PV, BQE46-1000-42-PV-S1
34594C	LFUC1-030W-02-21, BQE45C-750-40-PV, BQE46-1000-42-PV-S1
34594D	LFUC1-040W-02-21, BQE45C-1000-40-PV, BQE46-1000-42-PV-S1

The retrofit models are suitable to be installed to the luminaries as shown below.

◆ Min. 10cm between the LED strips or side of lamp compartment for recessed Luminaries.

◆ Min. 1.7cm between the LED strips for surface mounted Luminaries.

Retrofit Model	Luminaries Type	Minimum Lamp Compartment Size	Luminaries Outlook
34594A 34595A 34596A 34597A 34598A	Recessed	60cm x120cm x 6.8cm	
34599A 34600A	Recessed	60cm x60cm x 6.8cm	
34594A 34595A 34596A 34597A 34598A	Surface mounted	7cm x 120cm x 5cm	

WIRING DIAGRAM

Electrical Connection

1. Connect BLACK (line) driver lead to voltage supply Line position (HOT).
2. Connect driver WHITE lead to the NEUTRAL supply position.
3. Connect the GREEN ground lead to the supply ground lead.

If using 0-10V dimming:

4. Connect VIOLET lead to supply POSITIVE dimming lead.
5. Connect PINK lead to the supply NEGATIVE dimming lead.

If NOT using 0-10V dimming:

6. Ensure VIOLET and PINK 0-10V dimming leads are properly capped.

Wiring Diagram

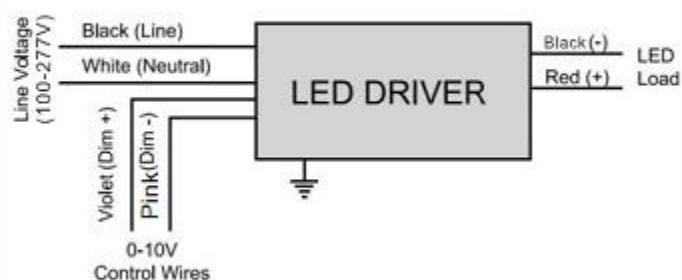

Before installing the product, please carefully read the installation instruction, inspect all the components, install according to current edition of national electronic code.

There are two different replacement installation methods for Existing troffer as below:

Installation method One :

Step1.Turn off all power from circuit breaker

Step 2. Open existing fixture

Step 3 .Remove all existing fluorescent tubes.

Step 4 .Remove ballast cover, cut all the wires connecting to ballast, and remove ballast

Step 5. Install the LED strip kits with extrusion aluminum heat sink to the existing fixture via magnets

Step 6. Replace old ballast with new LED driver via magnets and connect power with (Live and Neutral wire)

Step 7. Located ground wire and ground to fixture

Step 8 .Cover the LED driver with existing ballast cover

Step 9. Close the fixture cover

Step10.Turn power back on.

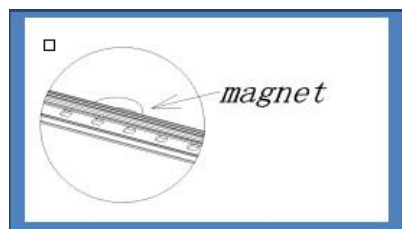
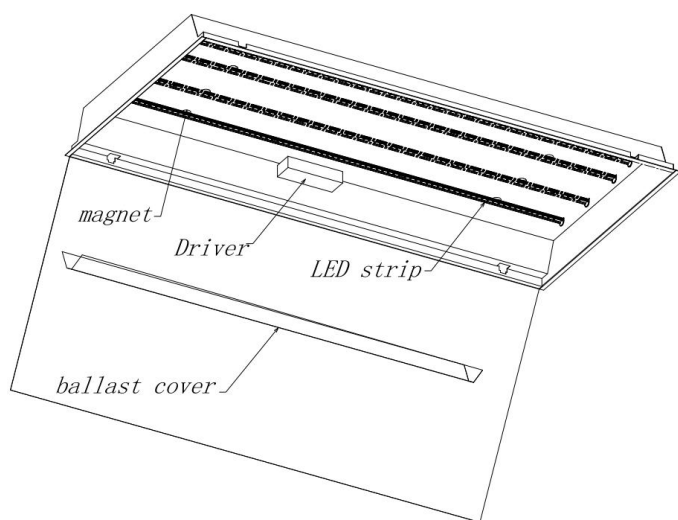

Installation method Two:

Step 1. Turn off all power from circuit breaker

Step 2. Open existing fixture

Step 3. Remove all existing fluorescent tubes

Step 4. Remove ballast cover, cut all the wires connecting to ballast, and remove ballast

Step 5. Install the LED strip kits with extrusion aluminum heat sink to the existing fixture via self-tapping screws

Step 6. Replace old ballast with new LED driver via magnets and connect power with (Live and Neutral wire)

Step 7. Located ground wire and ground to fixture

Step 8. Cover the LED driver with existing ballast cover

Step 9. Close the fixture cover

Step 10.Turn power back on

