

Specifications



Item - 35354A

Model - LED Under Cabinet 11/5K/24"

Bulb Type - LED

Watts - 11 watts

Input Voltage - 120V 60Hz

Dimmable - Yes

Height - 1 inches (25.4mm)

Width - 3.5 inches (88.9mm)

Length - 24 inches (609.6mm)

Kelvin Color - 5000

CRI - 90

Lumens - 700

Average Life Hours - 50,000

Ambient Operating Temp. - -40°F ~ 104°F (-40°C ~ 40°C)

Caution

- This fixture must be wired in accordance with the National Electrical Code (NEC) and applicable local ordinance. Proper grounding is required to ensure personal safety. Carefully observe grounding procedure under the installation section.
- Make certain power is OFF before starting the installation or attempting any maintenance. Risk of fire/electric shock. If not qualified, consult a licensed electrician.
- Disconnect power at fuse or circuit breaker before installing or servicing.
- RISK OF BURN - Disconnect power and allow the fixture to cool before servicing.
- RISK OF PERSONAL INJURY - Fixture may become damaged and/or unstable if not installed properly. Make sure all fixture components are securely tightened.

Precaución

- Este accesorio debe estar conectado de acuerdo con el National Código Eléctrico (NEC) y ordenanzas locales aplicables. Apropiado Se requiere conexión a tierra para garantizar la seguridad personal. Cuidadosamente observe el procedimiento de conexión a tierra en la sección de instalación.
- Asegúrese de que la alimentación esté apagada antes de comenzar la instalación o intentando cualquier mantenimiento. Riesgo de incendio / descarga eléctrica. Si no calificado, consulte a un electricista con licencia.
- Desconecte la energía en el fusible o en el interruptor de circuito antes de instalar o servicio.
- RIESGO DE QUEMADURAS: desconecte la alimentación y permita que el dispositivo se enfríe antes de dar servicio
- RIESGO DE LESIONES PERSONALES: el accesorio puede dañarse y / o inestable si no se instala correctamente. Asegúrese de que todos los accesorios. Los componentes están bien apretados.



NOTICE

DO NOT install this fixture outdoors.

DO NOT let power cords touch hot surface.

DO NOT mount near gas or electric heaters.

The use of accessory equipment is not recommended by the manufacturer. This may cause unsafe conditions.

Installation

1. Remove the lens from housing.
2. Remove top cover by hand or use a flat tip screwdriver (Figure 2)
3. Remove the knockout carefully. Insert the flexible conduit connector inside the fixture and tighten the nut. Tighten two screws on connectors after completing the final wiring.
4. Knockout key holes on the back of fixture housing for mounting.
5. Locate and mount the fixture on appropriate surface.
6. Make AC supply wire connection. (See wiring diagram below)
7. Install the top cover, ensure all wires and connectors are put back inside the fixture cover.
8. Install the lines back after completing installation.

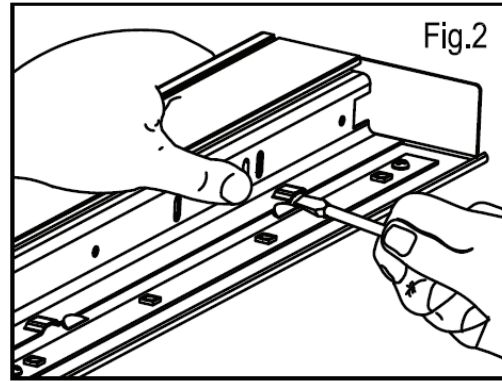
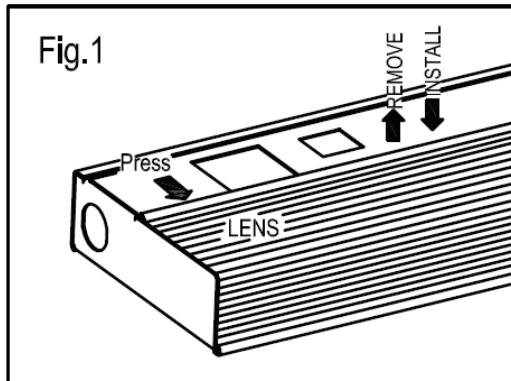

Wiring Diagram

WIRING DIAGRAM

