

## Specifications



Item	- 35599C
Model	- EMERGENCY DRIVER FOR T-Bay 35599B/35599D
Input Voltage	- 120-277VAC 50/60Hz
Output Voltage	- 11-56VDC
Input Current	- 100mA Max
Power	- 16W Max
Recharge Time	- 32 Hours
Discharge Time	- ≥90 minutes at 16W
Ambient Operating Temp	- 32°F to 122°F (0°C to 50°C)
Battery Type	- LiFePO4/9.6V/3000mAh
	- Suitable for dry/damp locations

## Dimensions

Length - 10.5" (267mm)

Width - 2.2" (56mm)

Height - 2.2" (56mm)

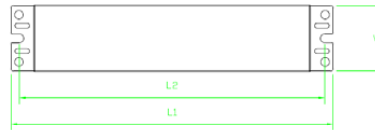

## Function

### SELF-TESTING:

Please turn off the main power every 3 months, so as to let the battery operate a charging/discharging cycle. This will help the battery maintain a longer lifespan.

Please check the emergency function with the push test button.

### NOTES:

Sealed unit. The battery is not replaceable, replace the entire unit when necessary.

### TEST Switch:

Emergency conversion kit will go into emergency mode if test switch is pressed when main supply is on, it will go into charging mode if test switch is not pressed.

**IMPORTANT:** An unswitched power source of 120-277VAC is required.

## Program Switch

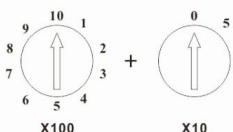
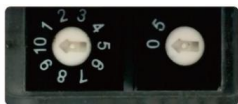

### Programmable Constant Current

- Pre-set by factory.
- Adjusting it from the preset will alter the emergency runtime.

## !IMPORTANT SAFEGUARDS!

WHEN USING ELECTRICAL EQUIPMENT, BASIC SAFETY PRECAUTION SHOULD ALWAYS BE FOLLOWED, INCLUDING THE FOLLOWING

### Read And Follow All Safety Instruction

1. CAUTION- DO NOT MOUNT NEAR GAS OR ELECTRONIC HEATERS.
2. CAUTION- EQUIPMENT SHOULD BE MOUNTED IN LOCATIONS AND AT HEIGHTS WHERE IT WILL NOT BE SUBJECTED TO TAMPERING BY UNAUTHORIZED PERSONNEL.
3. CAUTION- THE USE OF ACCESSORY EQUIPMENT NOT RECOMMENDED BY THE MANUFACTURER MAY CAUSE AN UNSAFE CONDITION.
4. CAUTION- DO NOT USE THIS EQUIPMENT FOR OTHER THAN ITS INTENDED USE.
5. Use with grounded, UL Listed, dry or damp location rated fixtures and case should be grounded.
6. The equipment is intended for ordinary locations and for permanent installation into one or more Listed luminaires.
7. Not for use in outdoor environments, heated air outlets, or hazardous locations.



**CAUTION: before installation, make certain the A.C. power is off.**

#### STEP1: INSTALLING THE EMERGENCY LED DRIVER

- > Test button and indicator light shall be installed where they can be seen depending on the application.
- > Turn off the AC power before installing.

#### STEP2: WIRING THE EMERGENCY DRIVER

- > The EMB and A.C. driver must be on the same branch circuit.
- > Select the appropriate wiring diagram to connect the emergency driver to the AC driver. For other diagrams, consult the manufacturer.
- > Use wire nuts to cover unused wires and make sure all connections are in accordance with the NEC and any local regulations.

#### STEP3: TESTING

- > After wiring is complete, check if the indicator light turns on or not , which will indicate the battery's charging status.

### Installation Instruction

- > Materials required for installation of emergency driver.

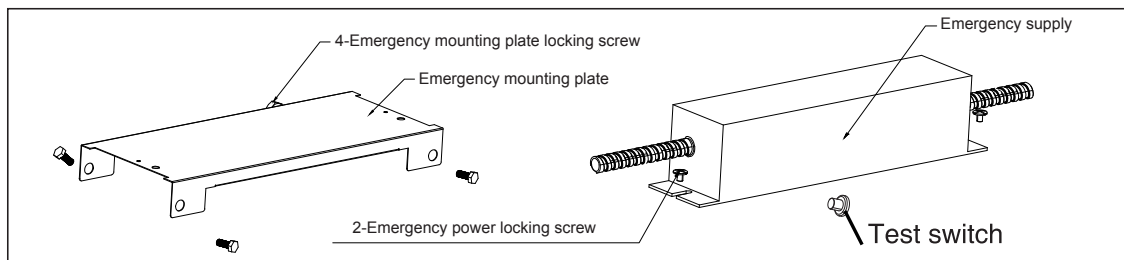

1. For 35599B/35599D, install the mounting plate to the fixture by mounting the 4 screws shown.

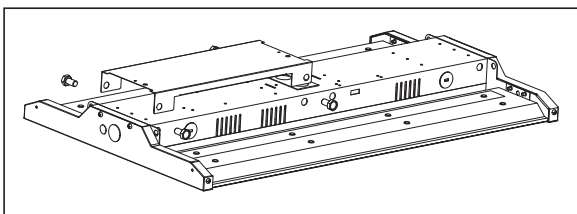

2. Mount the battery pack.

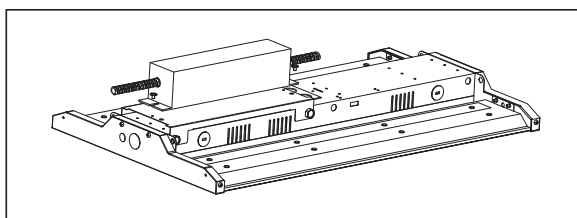

3. Remove knock out.

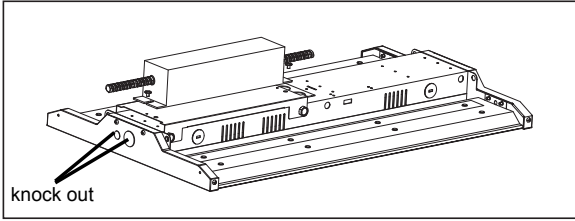

4. Making the electrical connections.

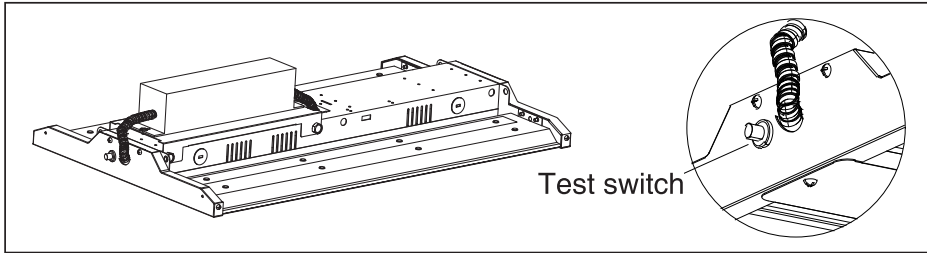

Wiring Diagram

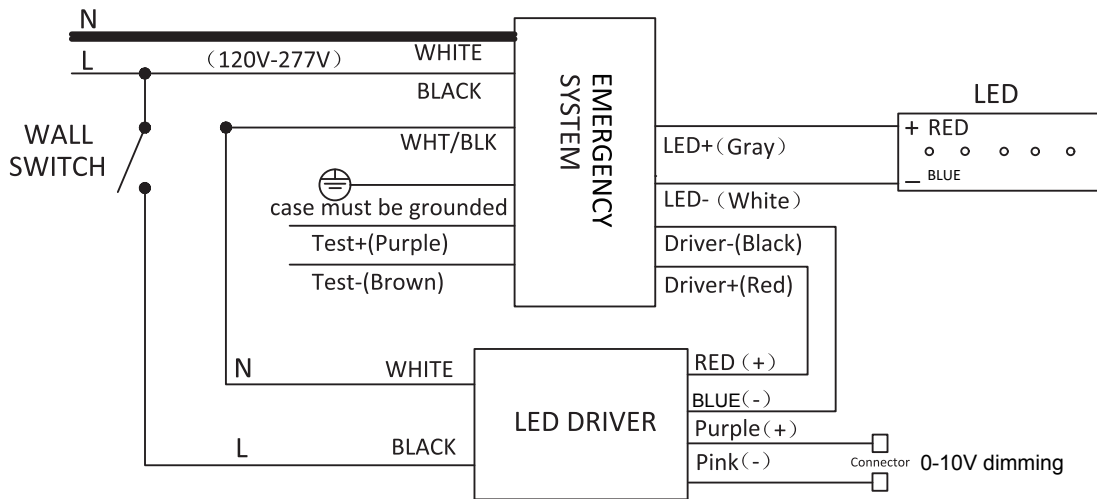

Note: The emergency driver is only wired to one fixture driver.  
When in emergency mode it will only power the LEDs from one fixture driver.