

3. According to the need, carry out the projection angle adjustment, angle adjustment range (Figure 12);
4. Complete the projection angle adjustment and lock the adjustment screw;
5. According to the previous wiring diagram and select one method for wiring.
Notice: Please use listed water proof strain relief bushing when connection the supply cord to the outlet box.

ADJUSTABLE FITTER MOUNTING (AM)

1. Loosen the 4 locking bolts on the slip fitter, connect the wire correctly and put the wire into pole. Then fasten the locking bolts between slip fitter and the pole. (Figure 13)
2. Loosen the fixing bolts and adjusting bolts, align the fixture to required angle. Tighten adjusting bolt and fixing bolts after the angle is confirmed. (Figure 14)
Notice: Adjustable angle is 0-90° (Figure 13).

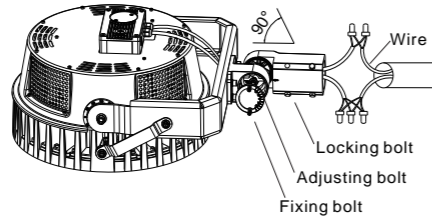

Figure 13

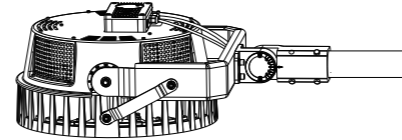

Figure 14

3. Use an open-end wrench and hex wrench to loosen the adjusting screw for adjusting the angle (Figure 15)
Notice: Adjustable angle is 0-90°.

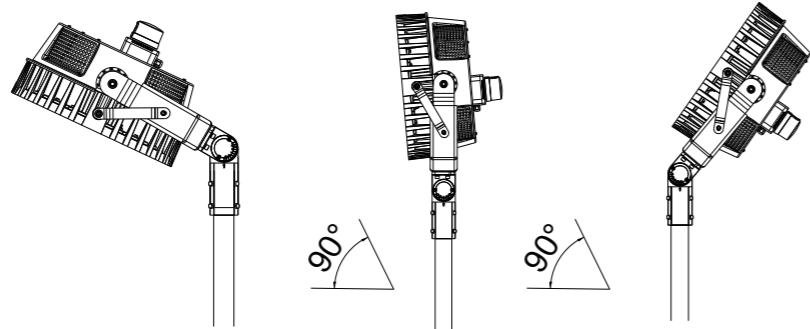

Figure 15

Instructions for light shield

When the light shield function is required, Fix the light barrier to the luminaire with a screwdriver as required. (Figure 16)

Instructions for Photocell

When the photocell function is required, photocell should be installed on the back of lamp. When it's not required, shorting cap should be installed on the back of lamp. (Figure 17)

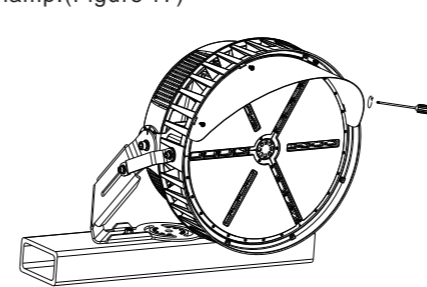

Figure 16

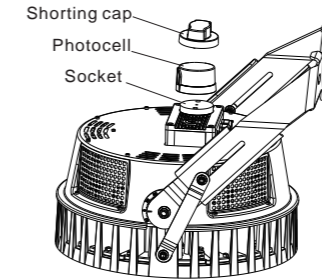

Figure 17

The explanation for wattage selection :

The light fixture with watt adjustable function, tear off the plug, switch it to the tap position you need. (Figure 17)

Note: only switch the tap position to "III", the light fixture recover to the standard status.

750W model: 450W, 600W, 750W, Factory setting: "750W" (Figure 18)

1200W model: 800W, 1000W, 1200W, Factory setting: "1200W" (Figure 19)

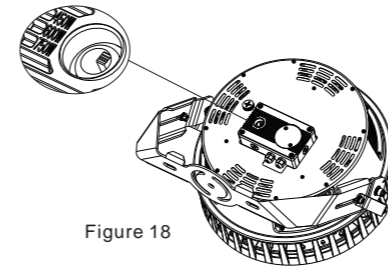

Figure 18

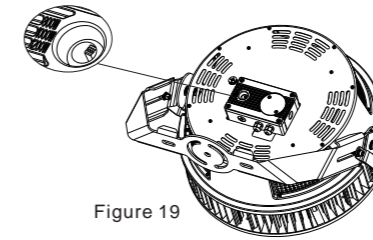

Figure 19

MIN 75 °C SUPPLY CONDUCTORS

THIS PRODUCT MUST BE INSTALLED IN ACCORDANCE WITH THE APPLICABLE INSTALLATION CODE BY A PERSON FAMILIAR WITH THE CONSTRUCTION AND OPERATION OF THE PRODUCT AND THE HAZARDS INVOLVED.

ALL COMPONENTS IN THE LUMINAIRE SHALL NOT BE REPLACED OR SERVICED.

LES FILS D'ALIMENTATION 75 °C

CE PRODUIT DOIT ÊTRE INSTALLÉ SELON LE CODE D'INSTALLATION PERTINENT, PAR UNE PERSONNE QUI CONNAÎT BIEN LE PRODUIT ET SON FONCTIONNEMENT AINSI QUE LES RISQUES INHÉRENTS.