

## Specifications

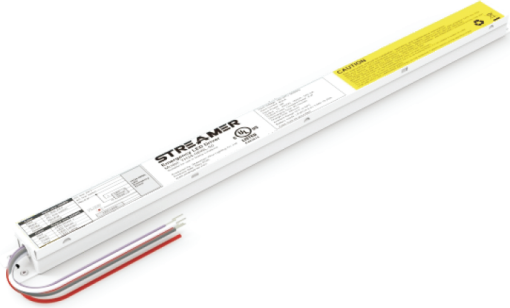

Item -	36657C
Model -	EMERGENCY DRIVER FOR PANEL 36657B/36659B/36659D
Input Voltage -	100-277VAC 50/60Hz
Output Voltage -	15-50VDC
Input Current -	80mA
Emergency Power -	8W max
Recharge Time -	24 Hours
Discharge Time -	≥90 minutes
Ambient Operating Temp -	50°F to 122°F (10°C to 50°C)
Battery Type -	LiFePO4/6.4V/3200mAh

Note: When installing the emergency driver (36657C) for the 2x2 or 2x4 panels, you must choose the 35K or 5K wiring diagram from the install sheet depending on which CCT you want in emergency mode. For 4K in emergency mode, either diagram can be used. Once installed, choose the corresponding CCT from the switch on the panel to match the chosen CCT for emergency mode.

## Dimensions

Length - 17.91" (455mm )  
Width - 1.18" (30mm)  
Height - 0.82" (21mm)

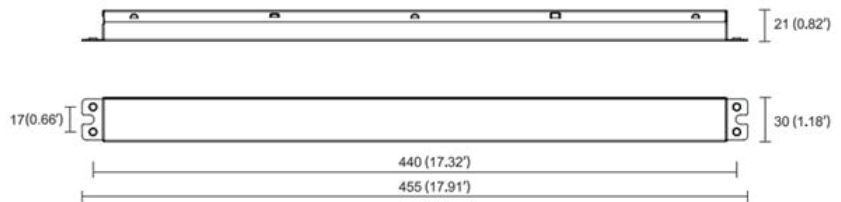

## Function

### Indicator Light

Red stable: charging mode or charging full.  
Red off: main power off or discharging mode.

### SELF-TESTING:

Please turn off the main power every 3 months, so as to let the battery operate a charging/discharging cycle. This will help the battery maintain a longer lifespan.

Please check the emergency function with the push test button.

### NOTES:

Sealed unit. The battery is not replaceable, Replace the entire unit when necessary.

### TEST Switch:

Emergency conversion Kit will go into emergency mode if test switch is pressed when main supply is on, it will go into charging mode if test switch is not pressed.

In emergency mode, press the test switch for 3 seconds to turn off the current emergency state.

# !IMPORTANT SAFEGUARDS!

WHEN USING ELECTRICAL EQUIPMENT, BASIC SAFETY PRECAUTION SHOULD ALWAYS BE FOLLOWED, INCLUDING THE FOLLOWING

## Read And Follow All Safety Instruction

1. CAUTION- DO NOT MOUNT NEAR GAS OR ELECTRONIC HEATERS.
2. CAUTION- EQUIPMENT SHOULD BE MOUNTED IN LOCATIONS AND AT HEIGHTS WHERE IT WILL NOT BE SUBJECTED TO TAMPERING BY UNAUTHORIZED PERSONNEL.
3. CAUTION- THE USE OF ACCESSORY EQUIPMENT NOT RECOMMENDED BY THE MANUFACTURER MAY CAUSE AN UNSAFE CONDITION.
4. CAUTION- DO NOT USE THIS EQUIPMENT FOR OTHER THAN ITS INTENDED USE.
5. Use with grounded, UL Listed, damp location rated fixtures and case should be grounded.
6. The equipment is intended for ordinary locations and for permanent installation into one or more Listed luminaires.
7. Not for use in outdoor environments, heated air outlets, or hazardous locations.



**CAUTION: before installation, make certain the A.C. power is off.**

**STEP1: INSTALLING THE EMERGENCY LED DRIVER**

- > Test button and indicator light shall be installed where they can be seen depending on the application.
- > Turn off the AC power before installing.

**STEP2: WIRING THE EMERGENCY DRIVER**

- > The EMB and A.C. driver must be on the same branch circuit.
- > Select the appropriate wiring diagram to connect the emergency driver to the AC driver. For other diagrams, consult the manufacturer.
- > Use wire nuts to cover unused wires and make sure all connections are in accordance with the NEC and any local regulations.
- > The fixture must be grounded.

**STEP3: TESTING**

- > After wiring is complete, check if the indicator light turns on or not, which will indicate the battery's charging status.

Installation Instruction

- > Materials required for installation of emergency driver.  
Note 1/2" drill bit and 18AWG wire will be needed for installation.

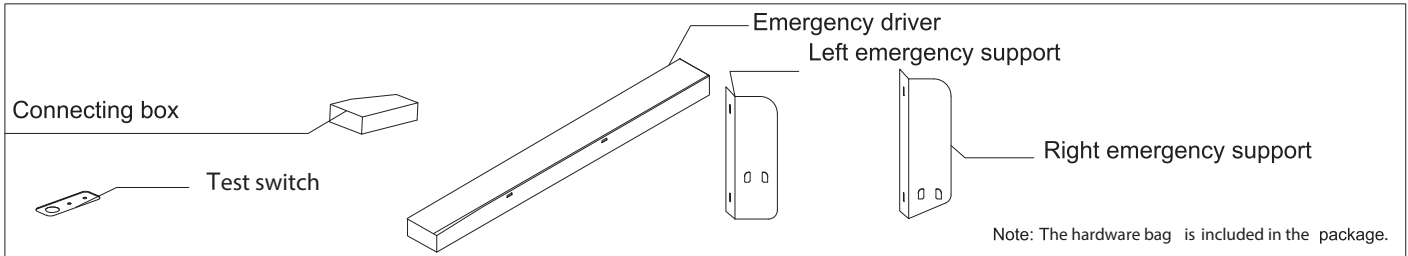

1. Drill a hole in the side of the driver enclosure per the diagrams below, for running wires and connections. Make sure there are no sharp edges that might cut the wires.

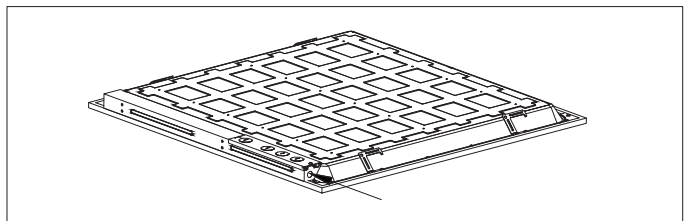
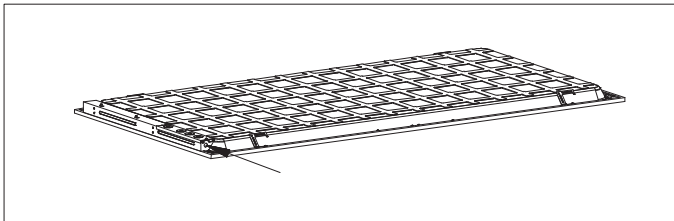

2. Emergency support mounting locations.

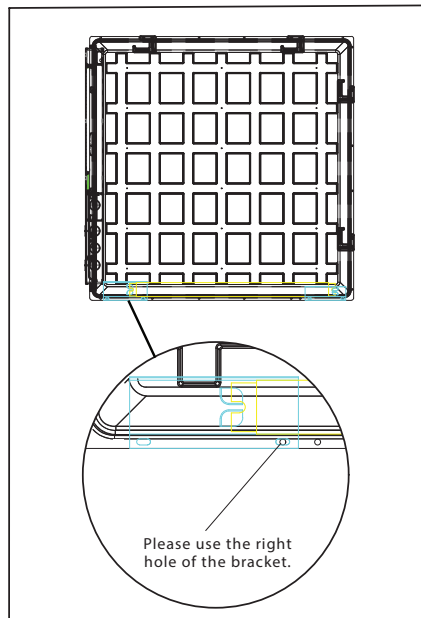
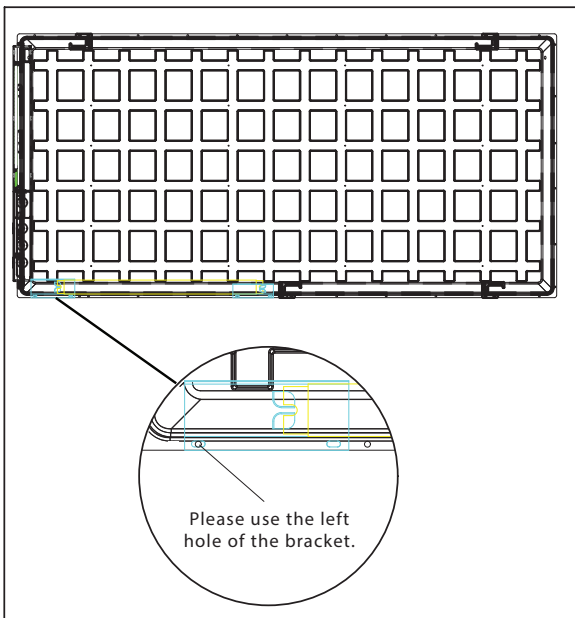

3. Install left and right emergency supports and install emergency battery. (Refer to General Wiring Diagram).

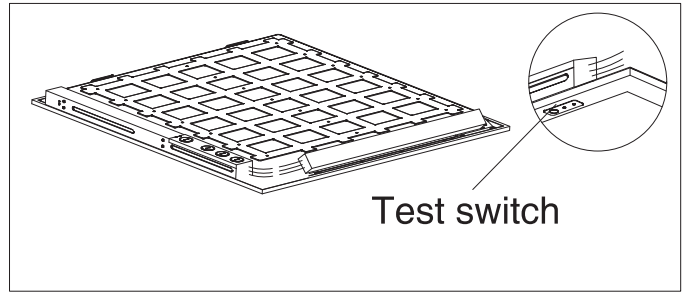
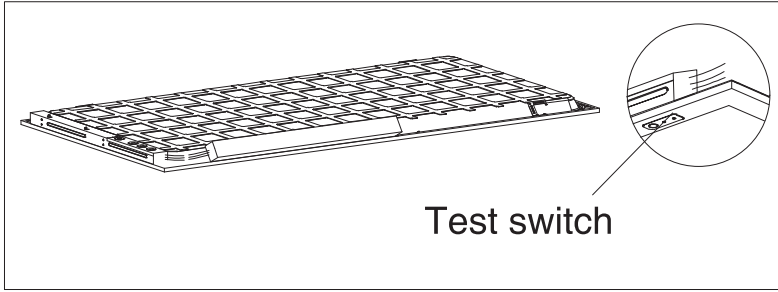

4. Make the electrical connections per the General wiring diagram. Four pieces of 18" wire(18AWG) will be needed to extend the driver output and LED input wires.

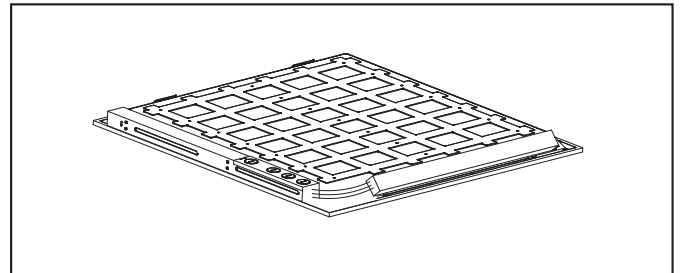
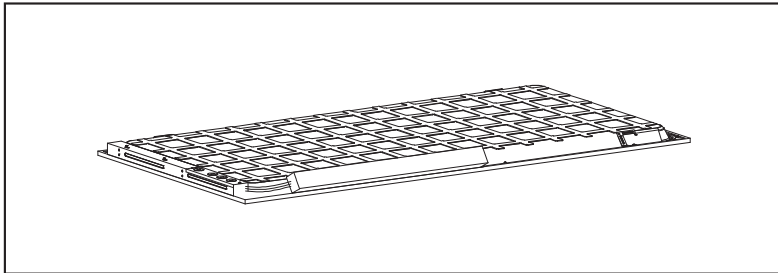

5. Attach the connecting cover to the driver enclosure and emergency driver. Verify all the wires and connections are covered.

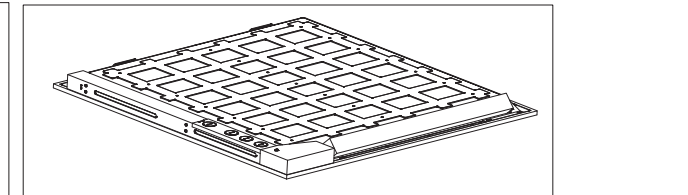
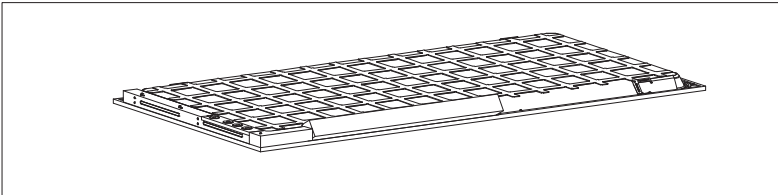

Note: When installing the emergency driver (36657C) for the 2X2 or 2X4 panels, you must choose the 35K or 5K wiring diagram below, depending on which CCT you want in emergency mode. For 4K in emergency mode, either diagram can be used. Once installed, choose the corresponding CCT from the switch on the panel to match the chosen CCT for emergency mode.

**Wiring Diagram**

Emergency CCT:  
3500K

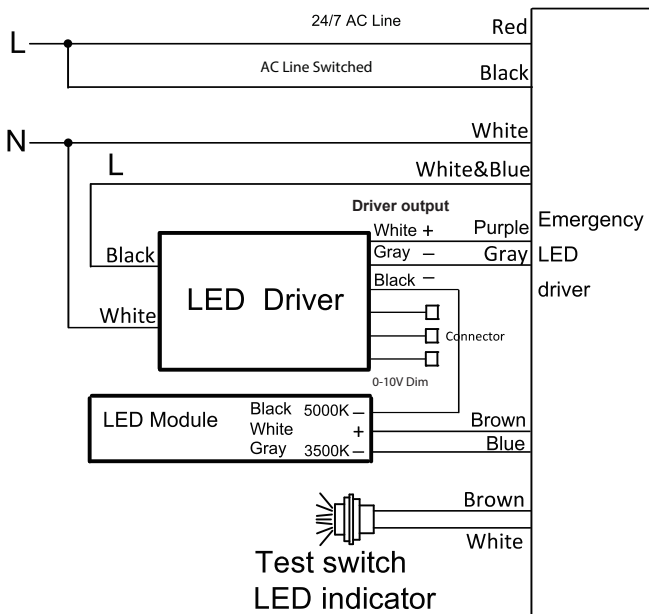

Emergency CCT:  
5000K

