

Specification

- Item - **37120B**
- Model - **LED STRIP 8FT WATT/ CCT Selectable**
- Bulb Type - **LED**
- Input Voltage - **120-277VAC 50/60Hz**
- Watts - **65/75/90W**
- Length - **94.2"(2392mm)**
- Width - **1.9"(48mm)**
- Height - **2.4"(61mm)**
- Color Temp - **3500K-5000K**
- CRI - **≥ 80**
- Lumen - **8450/9750/11700 lm**
- Lumen Efficacy - **130lm/w**
- Power Factor - **≥ 0.9**
- Finish - **White**
- Dimmable - **Yes, 0-10V**
- Damp Location - **Yes**
- Ambient Operating Temp - **-4°F to 122°F (-20°C to 50°C)**
- Life - **50,000 Hours**
- Average Beam Angle - **110°**
- Surge Protection - **2KV**
- **Motion Sensor Optional (37475A)**

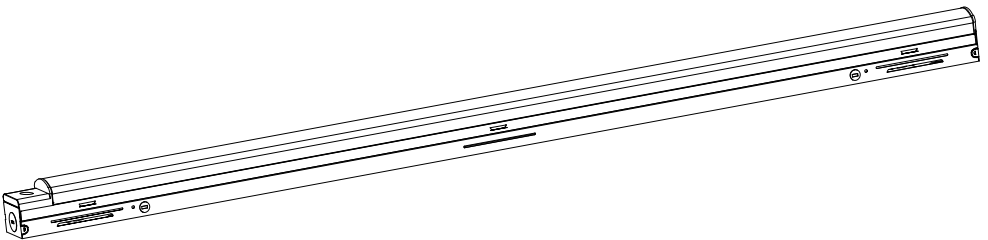

37120B

LED STRIP

DAMAR® Lighting
805 N Carnation Drive
Aurora, MO 65605 the World

Installation Instruction

⚠ WARNING

- To reduce the risk of death, personal injury or property damage from fire, electric shock, falling parts, cuts/abrasions, and other hazards read all warnings and instructions included with and on the fixture box and all fixture labels.
- Before installing, servicing, or performing routine maintenance upon this equipment, follow these general precautions.
- Commercial installation, service and maintenance of luminaires should be performed by a qualified licensed electrician.
- For the installation: If you are unsure about the installation or maintenance of the luminaires, consult a qualified licensed electrician and check your local electrical code.
- To prevent wiring damage or abrasion, do not expose wiring to edges of sheet metal or other sharp objects.
- Do not make or alter any open holes in an enclosure of wiring or electrical components during kit installation.

⚠ WARNING

- Turn off electrical power at fuse or circuit breaker box before wiring fixture to the power supply.
- Turn off the power when you perform any maintenance.
- Verify that supply voltage is correct by comparing it with the luminaire label information.
- All wiring connections should be capped with UL approved wire connectors.

⚠ CAUTION

- Avoid direct eye exposure to the light source while it is on.
- Account for small parts and destroy packing material, as these may be hazardous to children.
- Risk of burn. Disconnect power and allow fixture to cool before changing bulb or handling fixture.

NOTICE: Green ground screw provided in proper location. Do not relocate.

NOTICE: Minimum 90°C supply conductors.

NOTICE: Specifications and dimensions subject to change without notice.

NOTICE: Suitable for Dry or Damp location

General Wiring Diagram

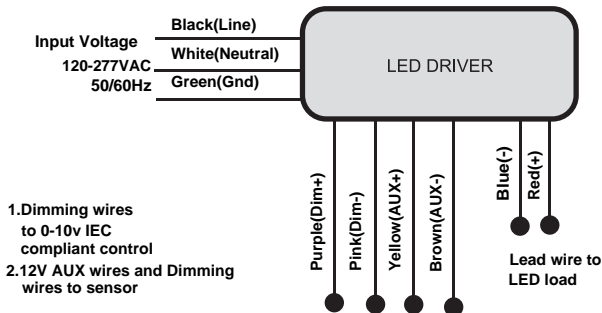

37120B

LED STRIP

DAMAR[®] Lighting
805 N Carnation Drive
Aurora, MO 65605
the World

Installation Instruction

Chain Suspended Mounting (NOT PROVIDED)

Notice: Always turn off the power supply from main circuit breaker first!

1. Take out the light fixture and accessories package from the box.

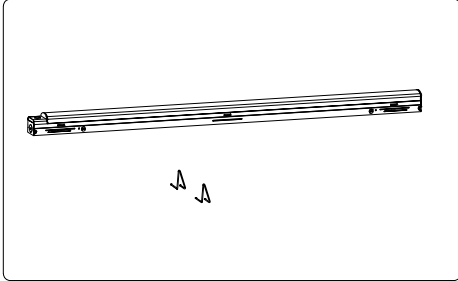

2. Connect the V-hook to the lamp.

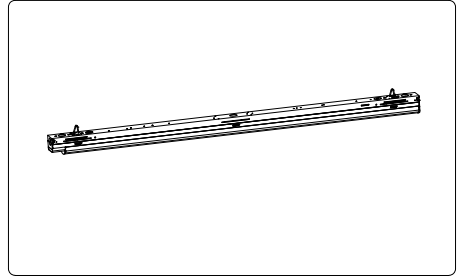

3. Attach chain to the V-hooks.

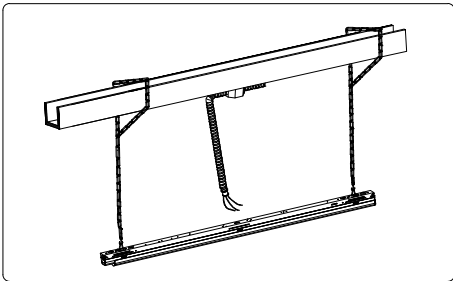

4. Connect the AC wires.

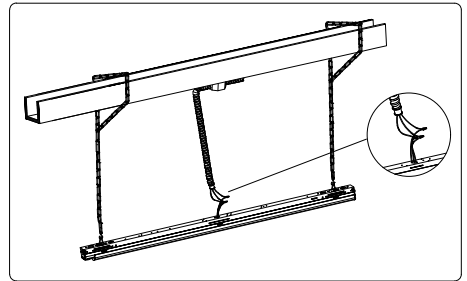

5. The installation is completed.

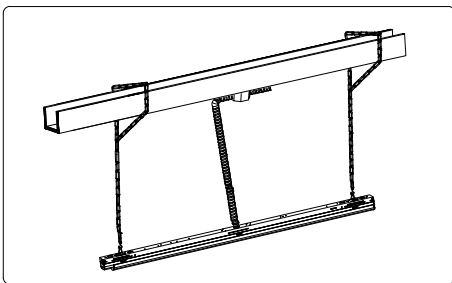

37120B
LED STRIP

DAMAR[®] Lighting
805 N Carnation Drive
Aurora, MO 65605 the World

Installation Instruction

Surface Mounting

Notice: Always turn off the power supply from main circuit breaker first!

1. Take out the light fixture and accessories package from the box.

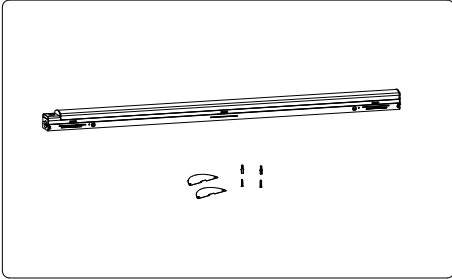

2. Attach the adapter plates to the back of the fixture with screws.

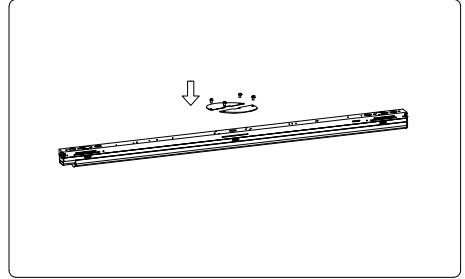

3. Open the module board down.

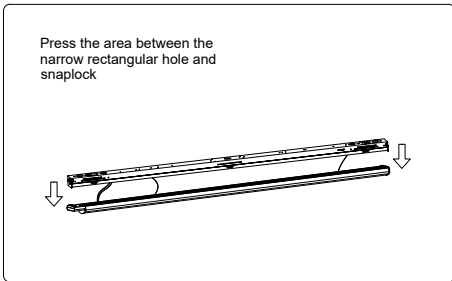

4. Mount the fixture to the ceiling with the plastic anchors and screws

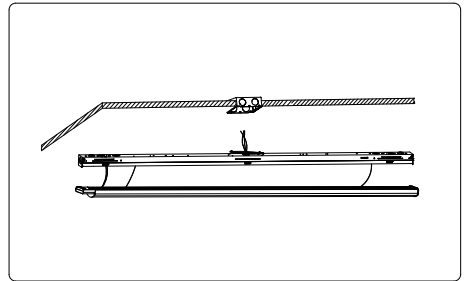

5. Wire to main power through the junction box.

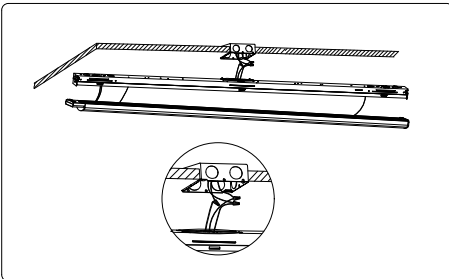

6. Assemble the module board upwards. The installation is completed.

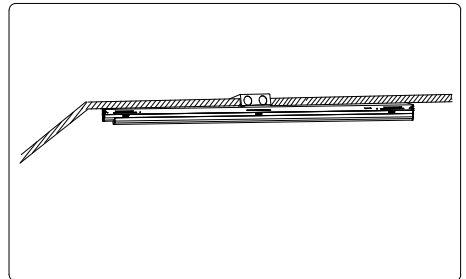

37120B
LED STRIP

DAMAR® Lighting
805 N Carnation Drive
Aurora, MO 65605 the World

Installation Instruction

Field-Adjustable Wattage & CCT

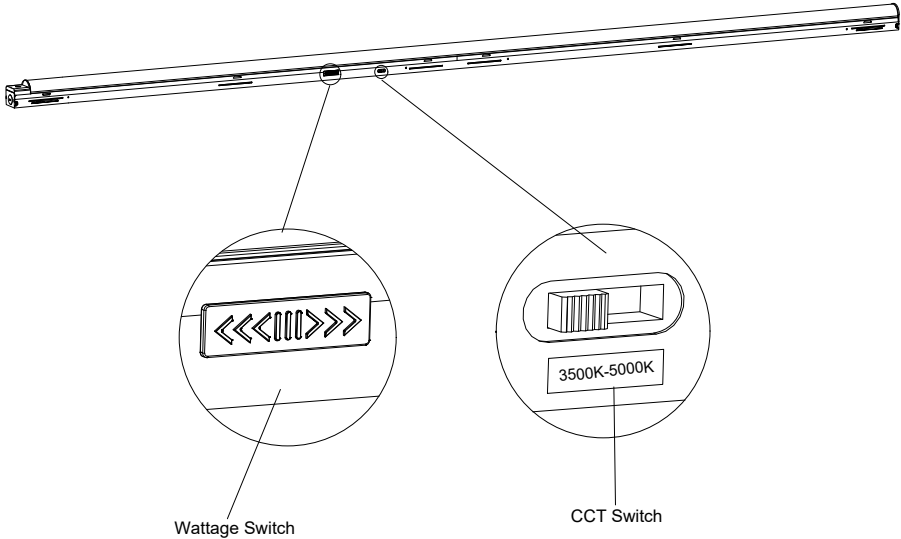

The end users may adjust the color temperature and lumen output respectively by the two DIP switches. Each DIP switch is adjustable with 3 options (left, middle and right), corresponding to 3 color temperatures and 3 powers respectively, which can perform the desired color temperature and lumen output combination.

- 1.DIP switches are located on the side of the fixture.
- 2.Select a wattage and color temperature by sliding switch left or right respectively to the desired value.

37120B
LED STRIP

DAMAR[®] Lighting
805 N Carnation Drive
Aurora, MO 65605 the World