

LED ARCHITECTURAL FLOOD LIGHT

Specifications



Item	- 37327A
Model	- LED ARCHITECTURAL FLOOD LIGHT
Bulb Type	- LED
Beam Angle	- 110°
Input Voltage	- 120-277VAC 50/60Hz
Watts	- 120W/160W/200W SELECTABLE
PF	- >0.9
Color Temp	- 3K/4K/5K SELECTABLE
CRI	- >70
Lumen	- 15600/20800/26000
Dimmable	- Yes, 0-10V
UL Rating	- Suitable for Wet Locations
Ambient Operating Temp	- -40°F to 113°F (-40°C to 45°C)
Length	- 12.56" (319 mm)
Width	- 8.03" (204mm)
Height	- 13.11" (333mm)
Finish	- Bronze
Life	- 50,000 Hours
Surge Protection	- 4KV
Yoke Mount	- Optional (37327B)
Slip Fitter Mount	- Optional (37327C)
Straight Arm Mount	- Optional (37327D)

Note

Any alteration or modification of this product is expressly forbidden as it may cause serious personal injury, death, property damage and/or product malfunction.

This luminaire is designed to operate in ambient temperatures ranging from -40°C to 45°C (-40°F to 113°F).

This product is not suitable for several special environments, such as places with corrosive gas, liquids, or high pressure water vapor. Suitable for wet locations.

Warning

PLEASE READ ALL INSTRUCTIONS BEFORE ATTEMPTING INSTALLATION

- To prevent personal injury or product damage only licensed electricians should install.
- To avoid electric shock or component damage disconnect power before attempting installation or servicing.
- Please wear gloves to avoid injury before installation.
- Disconnect product and allow cooling prior to servicing.
- To prevent product malfunction and/or electrical shock this product must be properly grounded.
- Do not use an electric generator to test LED fixtures.
- Please abide by related country, regional, and local law and regulations when installing this fixture.



Installation 1 Slip Fitter Mount

Step 1 Take the fixture out of package.

Step 2 Finish the wiring connections according to the wiring diagram (L=Black, N=White, G=Ground) and then route the wires into the lamp pole (figure 1.1).

Step 3 Loosen the screws. Adjust the fixture angle as per actual demands and tighten the screws when complete. Attach the bracket to the pole with screws, then connect the wires per proper wiring requirements (figure 1.2).

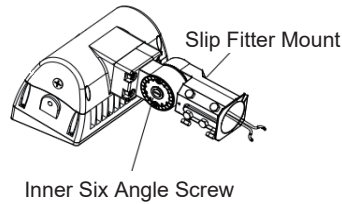

figure 1.1

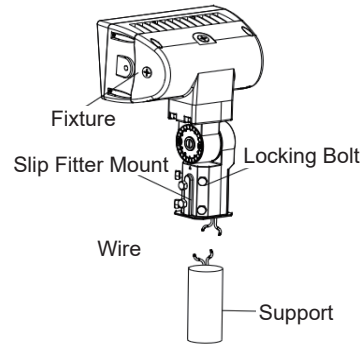

figure 1.2

Installation 2 Trunnion Mount (Included)

Step 1 Take the fixture out of package.

Step 2 Finish the wiring connections according to the wiring diagram (L=Black, N=White, G=Ground) and then route the wires appropriately (figure 2.1).

Step 3 Loosen the screws. Adjust the fixture angle as per actual demands and tighten the screws when complete (figure 2.2).

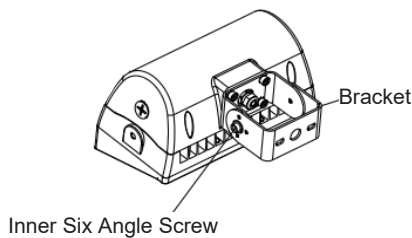

figure 2.1

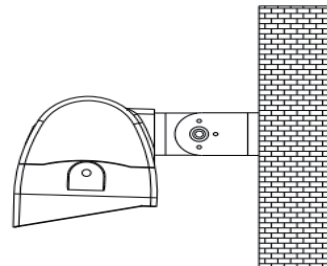

figure 2.2

Installation 3 Yoke Mount

Step 1 Take the fixture out of package.

Step 2 Finish the wiring connections according to the wiring diagram (L=Black, N=White, G=Ground) and then route the wires appropriately (figure 3.1).

Step 3 Loosen the screws. Adjust the fixture angle as per actual demands and tighten the screws when complete (figure 3.2).

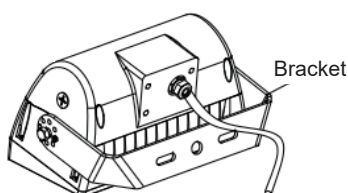

figure 3.1

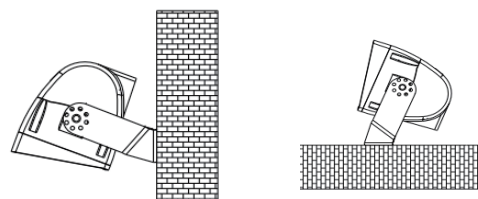

figure 3.2

Installation 4 Straight Arm Mounting

Step 1 Take the fixture out of package.

Step 2 Finish the wiring connections according to the wiring diagram (L=Black, N=White, G=Ground) and then route the wires appropriately (figure 4.1).

Step 3 Attach the bracket to the mounting surface with screws, then connect the wires per proper wiring requirements (figure 4.2). The fixture angle is adjustable.

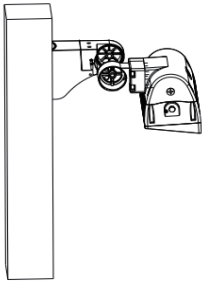

figure 4.1

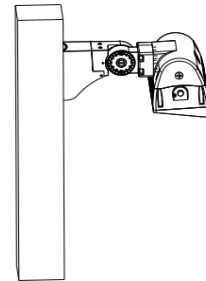
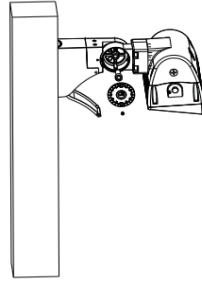
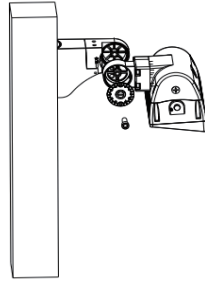
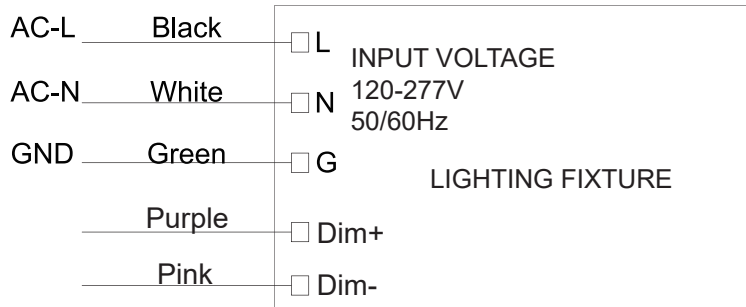

figure 4.2

Wiring Diagram



CCT & Power Select Guidance

Wattage Select:

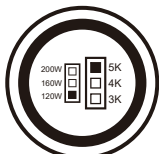

120W

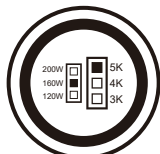

160W

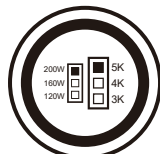

200W

CCT Select:

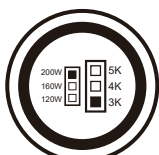

3K

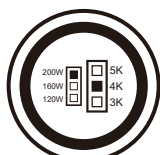

4K



5K

